



ALUMED

ALUMINIUM SYSTEMS

01-01-2020

Serie Varios

Mosquiteras

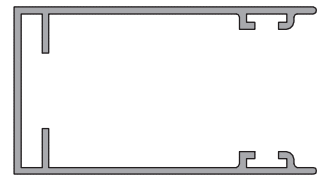
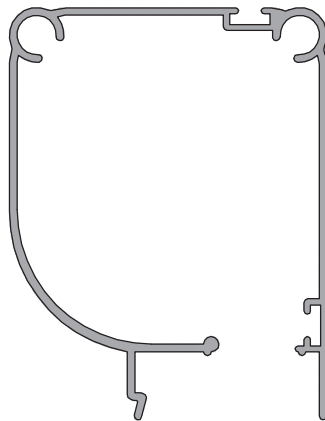
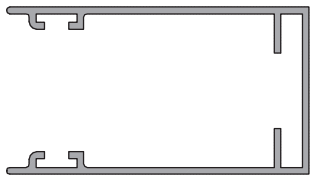

Mosquiteras - Relación de Perfiles.

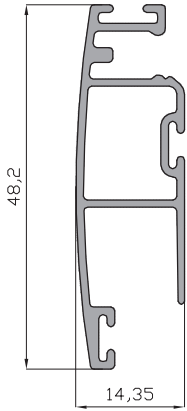

Perfil mosquitera Curvo
14320

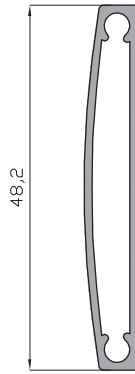

Travesaño mosquitera Curvo
99011

Tapa
12571

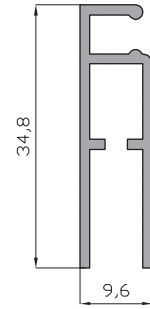

Perfil mosquitera
1492

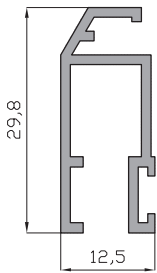

Hoja perfil mosquitera
54572

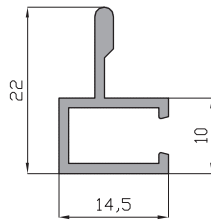

Marco perfil mosquitera
54570

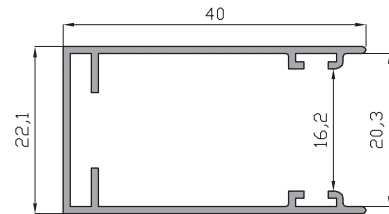

Guia lateral doble felpa
31002

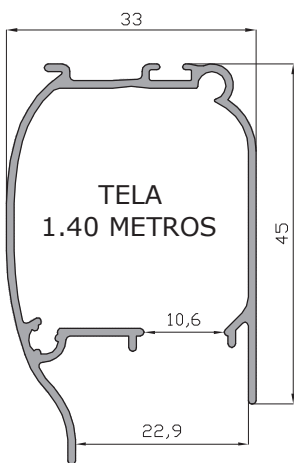

Cajón Mosquitera terminal tela
1.40 metros
31006

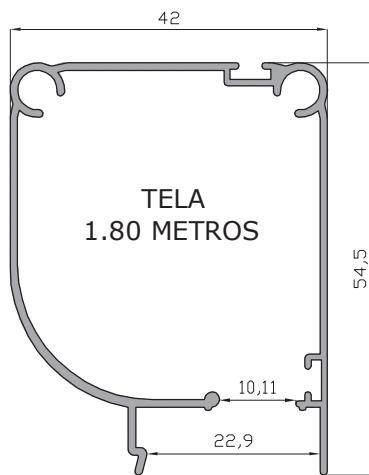

Cajón Mosquitera terminal tela
1.80 metros
31001

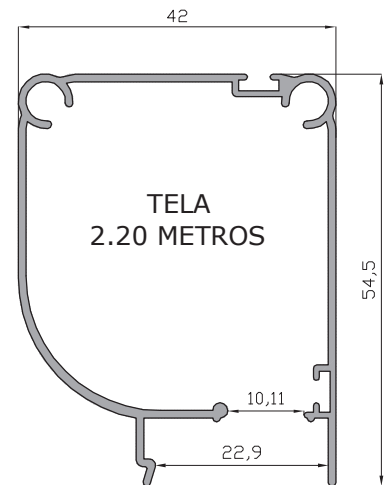

Cajón Mosquitera terminal tela
2.20 metros
31005

Mosquiteras - Relación de Accesorios.

- MOSQUITERAS CORREDERAS

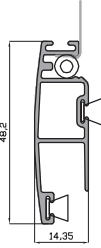

Perfil mosquitera Curvo
14320



Travesaño mosquitera Curvo
99011

72931	Kit mosquitera curva (14320)
12571	Juego unión travesaño (14320-99011)
510009	Felpudo 5x7 (14320)
24060	Goma mosquitera (14320-99009)
24044	Tela de mosquitera de 1200 mm

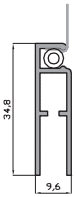

Perfil mosquitera
1492

24042	Goma mosquitera (54572-1492)
24043	Kit escuadra mosquitera (1492)
24044	Tela de mosquitera de 1200 mm

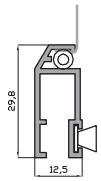

Hoja perfil mosquitera
54572

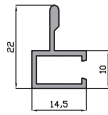

Marco perfil mosquitera
54570

33024	Kit escuadra mosquitera (54570-54572)
33025	Tornillo marco mosquitera (54570)
24042	Goma mosquitera (54572-1492)
24044	Tela de mosquitera de 1200 mm

- MOSQUITERAS ENROLLABLES

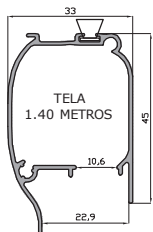

Cajón Mosquitera terminal tela
1.40 metros
31006

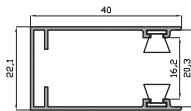

Guía lateral doble felpa
31002

31004	Kit mosquitera enrollable (1.40)
-------	----------------------------------

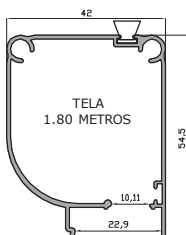

Cajón Mosquitera terminal tela
1.80 metros
31001

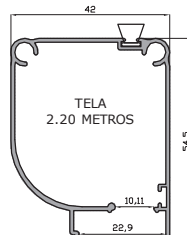

Cajón Mosquitera terminal tela
2.20 metros
31005

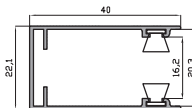

Guía lateral doble felpa
31002

31003	Kit mosquitera enrollable (1.80-2.40)
-------	---------------------------------------



ALUMED

ALUMINIUM SYSTEMS

"40 ANIVERSARIO"

www.alumed.es - www.alumedistemas.com

C/. Del Dracma - Parcelas 69-74
Buzón 20114 - POL. Ind. Las Atalayas
Tlfn. 965 170 026 - Fax. 965 170 032
03114 **ALICANTE**
alicante@alumed.es

Vial 3, Nave 16-17 - Pol. Son Llaut.
Telfn. 971 141 061 - Fax 971 141 064
07320 **SANTA MARIA DEL CAMI** (Mallorca)
mallorca@alumed.es

Pol. Ind. Fuente del Jarro
C/ Ciudad de Barcelona, 1R
Telfn. 961 345 275 - Fax 961 345 279
46988 **PATERNA** (Valencia)
valencia@alumed.es

Todos los datos incluidos en este catálogo son de carácter informativo. Alumed, no se hace responsable de posibles errores técnicos o de impresión. Asimismo Alumed reserva el derecho de introducir cambios o modificaciones sin previo aviso. Queda totalmente prohibido la reproducción parcial o total de este documento sin autorización de la propia empresa.